

22" PCAP Touch Screen Monitors

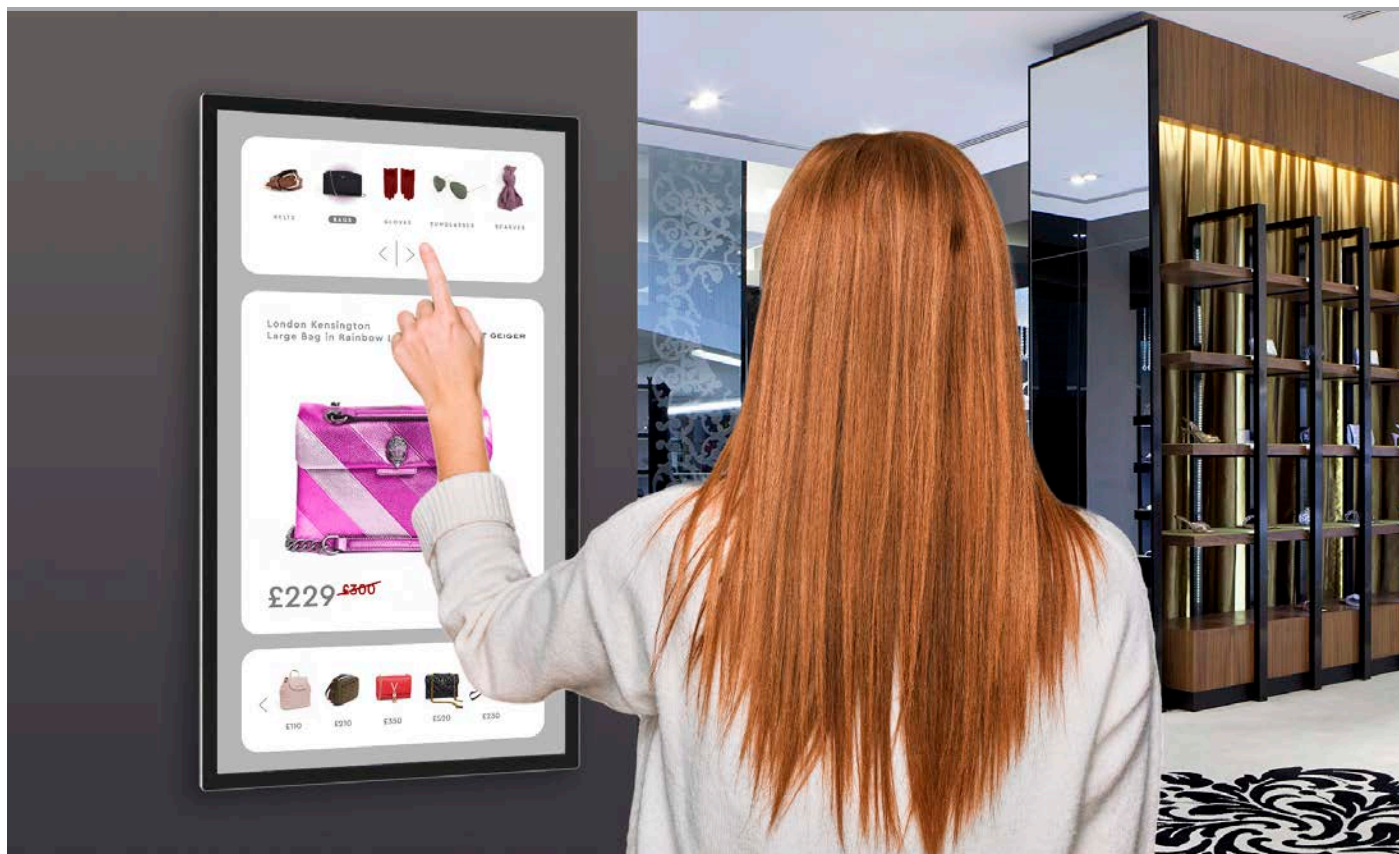

Interactive touch solution with open frame and integrated Windows options available; ideal for kiosk integration or wall-mounted applications

Optional Integrated Windows PC

Easily transform this solution from an interactive touch monitor into a fully integrated all-in-one Windows touch screen simply by inserting an OPS PC into the built-in slot, with no cables required. To prevent theft or damage, this can be secured with a hex security screw.



Open Frame Option

These open frame touch screen monitors are ideal for system integrators. With an underside mounting bracket included at no extra cost, this flexible solution can be mounted into any kiosk, table or cabinet in any direction or orientation. The bracket also features micro-adjustment in all three directions to enable flush-fit surface integration. Alternatively, these monitors can be wall or stand mounted thanks to their complete enclosure.



Connect External Devices



24/7 Commercial Grade



10-Point PCAP Touch



500cd/m² IPS Panel



Open Frame Mounting Bracket



Surface Plasma Treatment



Integrated Speakers



3 Year Commercial Warranty

Other Features

Attach External Devices

Connect these versatile touch screen monitors to an external source, such as a third-party PC or media player, using the HDMI and USB inputs to run any software desired.

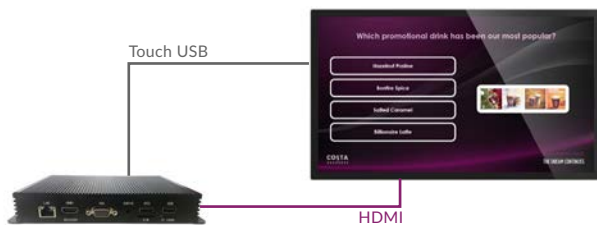

24/7 Commercial Use

These monitors are designed for continuous use in public spaces, able to be used 24/7 for over 70,000 hours. Built using true commercial grade components and having undergone rigorous quality control testing, they offer a reliable and cost-effective solution.



Giant Tablet Styling

A stylish edge-to-edge glass face, rounded corners, aluminium surround with unique concave indent profile, and thin black border deliver a captivating tablet-like aesthetic. The protective tempered glass face and mild steel enclosure also increase the durability of the display, protecting the LCD panel and other internal components from potential damage in public spaces.



Integrated Speakers

For applications that require an audio element, these monitors feature two integrated slimline speakers.

8W, 3Ω x 2
Integrated Speakers



Ultra Responsive Interactivity

Optimum sensitivity to touch gestures and rapid response times ensure that users have a smooth, effortless experience. There's no need to touch the same thing multiple times or wait for a touch to register when interacting with these ultra-responsive displays.



500cd/m² IPS Panel

With a brightness of 500cd/m², these monitors are ideal for brightly-lit public spaces. Plus, commercial grade IPS technology ensures accurate image quality and colour depth with no fall-off in colour accuracy, as well as achieving ultimate lifelike colour temperature in both landscape and portrait orientation.



Surface Plasma Treatment

A special oleophobic coating makes the glass front more resistant to the oily residue left by fingerprints, as well as improving the smoothness of touch gestures. Unlike some other touch screens, this glass is not etched and this vastly enhances the optical clarity.



PCAP Touch Technology

Industry-leading PCAP technology delivers a seamless touch experience, with sleek edge-to-edge glass, superior optical quality and up to ten touch points. Not only does this allow users to perform a variety of touch gestures, including manipulating images and zooming in/out, it also allows multiple users to interact with the touch screen at once.

10
Touch Points



Key Features

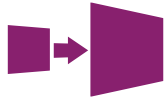

OPS PC SLOT



24/7 COMMERCIAL USE



INTEGRATED SPEAKERS



550CD/M² BRIGHTNESS



LANDSCAPE OR PORTRAIT ORIENTATION



MICRO ADJUSTMENT OPEN FRAME BRACKET



TOUGHENED FRONT GLASS



CONNECT EXTERNAL DEVICES

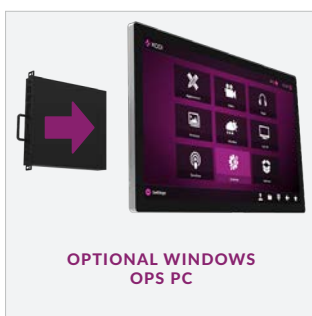

OPTIONAL WINDOWS OPS PC

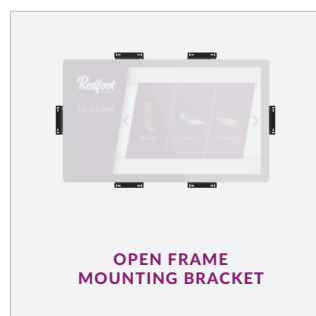

OPEN FRAME MOUNTING BRACKET



SURFACE PLASMA TREATMENT

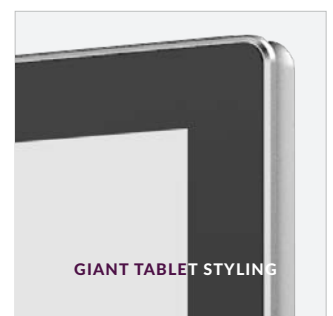

GIANT TABLET STYLING

Specification Table

		22 Inch
Panel	Resolution	1920x1080
	Display Area (mm)	476.4x267.8
	Aspect Ratio	16:9
	Brightness (cd/m ²)	500
	Colour	16.7M
	Viewing Angle	178°
	Contrast Ratio	1,000:1
Touch	Touch Technology	Projected Capacitive
	Touch Points	10
	Glass Hardness	7H minimum
	Glass Thickness	3.0±0.2mm
Audio	Speaker Type	8W (x2)
AV Inputs	Inputs	HDMI
Power	Power Consumption (W)	40
	Input Voltage	AC100-240V (50Hz-60Hz)
Mechanical	Unit Size (WxHxD mm)	526.2x322.8x60.8
	OPS PC Specification	200x119x30 (OPS)
	Package Size (WxHxD mm)	597x375x115
	VESA Holes (mm)	100x100 M5
	Net Weight (kg)	7.9
	Gross Weight (kg)	10.1
Environmental	Operating Temperature	0 °C to 40 °C
	Storage Temperature	-20°C to 60°C
	Operating Humidity	10% to 80%
	Storage Humidity	5% to 95%
Accessories	Included	Open Frame Mounting Bracket, Remote Control, User Manual, Power Cable, USB to USB Cable, Wi-Fi Aerial
	Optional	Windows Slot-in OPS PC, Wall Mount, Floor Stand/Trolley, Ceiling Mount, Table Stand
Warranty	Warranty Period	3 Year Warranty
	Technical Support	Lifetime

Errors and omissions excepted



Technical Drawing

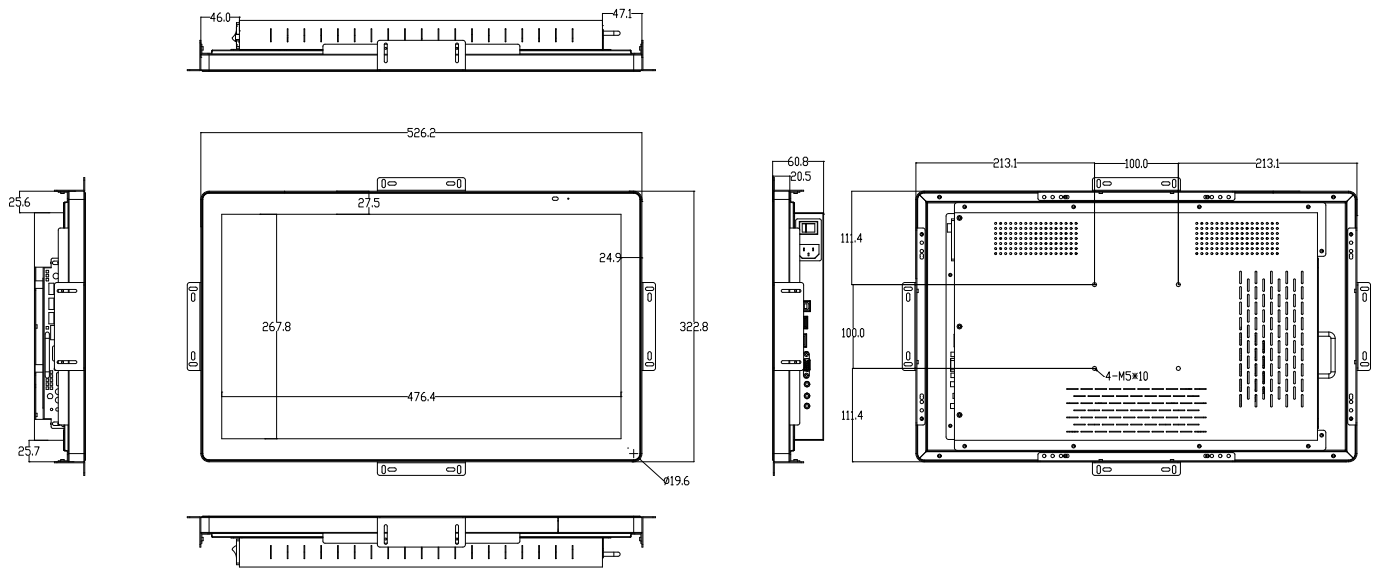

Why Choose Our Commercial Display Solutions?



Lifetime Technical Support

From the moment you receive your product, throughout the duration of your warranty and even after your warranty has expired we are here to support you. If you require any assistance setting up or using your product, or have any problems at all, we can provide free technical support via telephone and email.

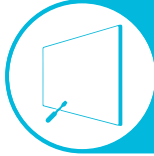

On-site Support and Maintenance*

If needed, we can provide an installation service for any of our products. We can also set up service-level agreements for larger projects that require maintenance contracts.



Extended Warranty*

All of our commercial display products come with a 3 year commercial warranty as standard but if you want to extend this you can upgrade this to cover a 5 year period at point of purchase.



Training

As well as providing free remote CMS training sessions and webinars we can also visit you to deliver bespoke training for our software and hardware*.



Advanced Replacements†

Should your display suffer from any kind of hardware failure during the warranty period we will send you an advanced replacement and arrange for your old display to be collected, free of charge. This ensures no downtime where you are without a screen.



Custom Product Testing & Configuration

If you need us to test third party software or a website, or configure your screen in a particular way before it is dispatched (e.g. in a particular orientation or network mode), we can do so to make your life easier.



3D Rendering

Want to know how a particular screen will look once installed? Send us a photo of the location and we will create a 3D rendering of any screen in situ to help you to visualise how amazing it will look.



Logistics Support

We hold more stock in our UK warehouse than any other manufacturer so we can help you meet tight deadlines. For last minute orders we can also offer special express or morning delivery options*. We also carry out UK based quality control checks on every display before it leaves our warehouse.



Project Support

If you need to loan a sample unit to test we'd be more than happy to arrange this. We can also provide a rental service for temporary projects*.



Customisation*

Your display can be customised to suit your requirements by adding your logo or printed graphics or even tailoring the colour of a display. We can also carry out hardware modifications to existing products or manufacture bespoke solutions for special projects.



Extras*

As well as being able to provide accessories and add-ons, such as extra remote controls, NUC PCs and video wall controllers, we can also supply custom made flight cases which are great if a display needs to be moved safely from place to place.

†UK mainland only

*These particular services may incur additional charges